



How Can Indian Railways Service the Steel Sector Better?

G Raghuram
Rachna Gangwar

W.P. No. 2009-04-04
April 2009

The main objective of the working paper series of the IIMA is to help faculty members, research staff and doctoral students to speedily share their research findings with professional colleagues and test their research findings at the pre-publication stage. IIMA is committed to maintain academic freedom. The opinion(s), view(s) and conclusion(s) expressed in the working paper are those of the authors and not that of IIMA.



INDIAN INSTITUTE OF MANAGEMENT
AHMEDABAD-380 015
INDIA

How Can Indian Railways Service the Steel Sector Better¹?

Abstract

The focus of this paper is on how Indian Railways can service the steel sector better. The steel sector is a core sector, with railways playing a critical role in its logistics. The paper examines the changing industry structure and brings to light the increased need for transportation, as compared to normal planning processes. Traditionally, crude and finished steel making was done in the same location by big producers having integrated plants. Now the industry has a large number of producers who primarily focus on crude steel making or finished steel making, necessitating the need for transporting crude steel to the finished steel makers. Even within finished steel making, there could be levels of value addition where the output of one finished steel maker could become the input for another.

This has implications for the transporters including Indian Railways in formulating their strategies. Further, based on the growth projections of the steel sector and a possible increased share of rail transport, Indian Railways need to strategize for a six fold increase in traffic. This could be upto 1 billion tons of originating traffic by 2019-20. The papers examines the current issues in rail transport for the steel sector and proposes strategies for the way forward under the dimensions of infrastructure, technology and systems.

¹ Prepared by Prof. G. Raghuram and Ms. Rachna Gangwar, Indian Institute of Management Ahmedabad. Contact e-mail: graghu@iimahd.ernet.in

Research assistance provided by Harpal Dave, Rishabh Pandey and Sakshi Sahni is acknowledged.

This paper is an outcome of the work done as part of the Indian Railways Chair in Rail Transport and Infrastructure Management, Indian Institute of Management, Ahmedabad for the year 2008-09.

How Can Indian Railways Service the Steel Sector Better?

1. Introduction

The steel sector in India has been growing at a compounded annual growth rate (CAGR) of 11.6% for crude steel production during 2003-08. This is above the international CAGR of 6.5%. At a production of 55mt of crude steel during the calendar year 2008, India was the 5th largest steel producer in the world, behind China, Japan, USA and Russia (Exhibit 1). India accounted for about 4 per cent of the world's total production in 2008.

As per the National Steel Policy 2005 (NSP), based on a production of 38mt in 2004-05 and a CAGR of 7.3%, the production is expected to reach over 110mt by 2019-20. With further imports of 6mt and exports of 26mt, steel consumption in India is expected to reach 90mt. With steel production reaching about 55mt in 2007-08, at the CAGR of 7.3%, it would reach 73mt in 2011-12, and 128mt in 2019-20. (This policy does not clarify the capacity in terms of crude or finished steel).

Nonetheless, with the current rate of ongoing greenfield and brownfield projects, the Ministry of Steel has projected India's steel production capacity to touch 124mt even by 2011–12. In fact, based on the status of Memoranda of Understanding (MoUs) signed by the private producers with the various State Governments, India's steel production capacity could be 293mt by 2020 (Exhibit 2).

As per the Steel Minister, Mr Paswan, “going by an estimate of US\$ 811 million investment per mt of additional capacity, the sector is likely to see an investment of US\$ 56.13 billion by 2012 and US\$ 176.49 billion by 2020.”

Paswan further informed that private and public sector steel companies are on a major capacity expansion spree. State-run SAIL's crude steel production is likely to reach 26mt by 2010 and 60mt by 2020 from the 14.6mt in 2006-07. RINL's crude steel production capacity will be increased from 2.9mt in 2006-07 to 6.8mt by 2011–12 and 10mt by 2020. Private steel industries like Tata Steel, JSPL, Ispat and JSW Steel also have major expansion plans on the anvil.

India is the fifth-largest consumer of steel in the world. Demand for steel in India is likely to grow at around 12% against the global average of 5-6%. A Credit Suisse Group study states that India's steel consumption will continue to grow by 16% annually till 2012, fuelled by demand for construction projects worth US\$ 1 trillion. The scope for raising the total consumption of steel is huge, given that per capita steel consumption was only 46 kg in 2006 – compared to 150 kg across the world, 250 kg in China and 400 kg in developed countries. About 60% of the country's steel production is used by the construction and infrastructure sectors.

2. Steel Industry Structure

The steel industry broadly consists of raw material sourcing, crude/liquid steel making, and finished steel making. In the traditional integrated steel plants, the crude and finished steel making was done in the same location. Over time, this has changed. There are a large number of producers who primarily focus on crude steel making and similarly many others who primarily focus on finished steel making. Even within finished steel making, there could be

levels of value addition where the output of one 'finished' steel maker could become the input of another.

A form of solidified liquid steel called pig iron is also manufactured by many players. Pig iron is used both as an input for finished steel and sold directly to a large number of small and medium industries who need small quantities of iron.

Slag is an important byproduct of the crude steel making process, constituting about 30% of crude steel output. Traditionally, this was sent to a dump in the steel plant location. Increasingly, it is being used for cement making, sometimes in cement plants in the vicinity and sometimes in captive plants.

The raw material requirements are of three kinds: iron ore, coking coal/coke (high value thermal coal can be used directly in certain processes), and fluxes consisting of limestone and dolomite. With best quality raw material, the requirements would be about 3 times the expected crude steel output. Iron ore would constitute 55%, coking coal/coke about 31%, and fluxes about 14%.

Sometimes iron ore is pre processed to sponge iron in stand alone sponge iron plants and sold as raw material to crude steel makers. While this improves the raw material quality in the traditional process, it is a requirement in many small units which are designed to use the same. India has the largest sponge iron industry in the world. There are two types of sponge iron making: gas based and coal based. While iron ore is the primary solid raw material for gas based sponge iron, iron ore, thermal coal and fluxes constitute the solid raw material for coal based sponge iron. The iron ore requirement for a gas based plant would be about 1.6 times the output. In a coal based plant, the raw material requirement would be 3 times, of which iron ore would constitute 55%, coal 40%, and fluxes 5%.

Other raw material improvement processes like sintering of iron ore and converting coking coal to coke, if required, are done within the premises of a steel plant.

Many steel plants also have captive electricity generating units, since power is a critical input in steel making. These units require thermal coal.

All the above elements of the industry structure have implications for movement of raw material, intermediate products including sponge iron, crude steel, and pig iron, and finished steel products. Exhibit 3 gives the overall industry structure with the possible movement requirements.

The crude steel manufacturers are classified as 'main' producers (RINL, SAIL plants – four large and one small, and Tata Steel), 'major' producers (Essar Steel, Ispat Industries, and JSW Steel), and 'other' producers (comprising of large number of about 650 mini steel plants based on electric furnaces and energy optimizing furnaces). The finished steel manufacturers are classified as 'main' (in the case of SAIL, apart from the five mentioned, there are two more small plants) and 'major' as already defined and 'other' (cold rolling mills, galvanizing/color coating units, and small to medium sized long and flat product manufacturers, totaling to over 1200 units).

3. Transport Flows

The authors have tried hard to assess the transport flow numbers in Exhibit 3, since ready information on location, nature of products, and production is not available.

The production of finished steel, based on the Ministry of Steel annual report, was 52.5mt in 2006-07. Of this, 17.6mt was from the 'main', 11.6mt from the 'major', and 28.4 from the 'other' producers. Amongst the 'major' and 'other' producers, 5.1mt was interplant internal movement for value added processing. Hence, the net finished steel for movement from the 'major' and 'other' producers was 34.9mt.

The crude steel and pig iron production, based on the Ministry of Steel annual report, was 55.8mt in 2006-07. Of this, 22.1mt was from the 'main', 8.4mt from the 'major', and 20.2mt from the 'other' producers. Pig iron production was 5.0mt. Of the 22.1mt crude steel from the 'main' producers, 17.6mt was the interplant internal movement for finished steel making. We assume that the remaining 4.5mt moved to 'major' and 'other' producers for finished steel making. This 4.5mt, along with the 28.6mt of 'major' and 'other' producers, and 1.8mt of pig iron is assumed to have moved to 'major' and 'other' finished steel producers, for the total requirement of 34.9mt of finished steel output. (An increasing, but insignificant amount of crude steel was exported). Out of the 5.0mt of pig iron produced, we assume that the balance 3.2mt was sold in the market to various downstream industries.

Raw material requirement is estimated at 3 times the crude and pig iron production ie 167.4mt. Of this, 18.3mt, being the total sponge iron industry output, was raw material input. Of the remaining 149.1mt, 55% was iron ore (82.0mt), 31% coal/coke (46.2mt), and 14% fluxes (20.9mt). Of the sponge iron output, 5.2mt was gas based and 13.1mt was coal based. The gas based production required 8.3mt of iron ore (being 1.6 times the output). The coal based production required 39.3mt of raw material. Of this, 55% was iron ore (21.6mt), 40% thermal coal (15.7mt), and 5% fluxes (2.0mt).

The raw material requirement can be restated commoditywise:

- Iron ore figure of 111.9mt is the total of 82.0mt for crude steel making, 8.3mt for gas based sponge iron making, and 21.6mt for coal based sponge iron making.
- Coal figure of 61.9mt is the total of 46.2mt coking coal/coke for crude steel making, and 15.7mt thermal coal for coal based sponge iron making.
- Fluxes figure of 22.9mt is the total of 20.9mt for crude steel making, and 2.0mt for coal based sponge iron making.

We summarize the above transport requirements for 2006-07 in table 1.

Some of the numbers could be under estimates like the raw material requirement for crude steel making, since this is dependant on the quality of the raw material. Similarly, figures like sponge iron movement for crude steel making, and crude steel movement for finished steel making could be upper bounds, depending on the level of integration in the newer steel plants.

For a finished steel output of 52.5mt and a direct pig iron sale of 3.2mt during 2006-07, the total movement requirements for the domestic steel industry (excluding thermal coal for captive thermal power plants, slag to cement plants, and cement from captive cement plants) was 305.6mt. This also excludes in plant movements of both crude and finished steel, and slag.

As per the NSP, it is estimated that every ton of ‘steel’ production involves transportation of 4 tons of material including 3 tons of raw material. *As per our estimation, given the current industry structure, the total transportation including intermediate products is at least 5.5 and more likely 6 tons for every ton of finished steel production.* However, for a given crude steel plant, the figure of 4 tons per ton of production would be valid. (In reality, based on the authors’ experience with some steel plants including JSW Steel [Raghuram G and R Gangwar, 2009], the actual movement could be upto 4.5, based on raw material quality).

It is quite imperative that both the steel and transport sectors evolve a more rigorous understanding of the industry structure, so that it can be used appropriately for strategizing for the future.

4. Transport Trends

We project India’s crude steel production figure at 100mt in 2011-12, based on a lower bound of 7.3% CAGR (73mt) as per the NSP and an optimistic perspective of the MoUs materializing (124mt). Similarly, for 2019-20, we project the figure at 200mt, based on a 9.1% CAGR from the 100mt in 2011-12. This would seem feasible, since the MoUs indicate a possible capacity of 293mt. Given the current industry structure, we expect the finished steel output to be almost of the same order of the crude steel output, 35% through inplant transfer and 65% through interplant movement.

As per the NSP, while we expect at least 25% of the production (partly as crude steel and partly as finished steel) to be exported, the steel imports are planned not to exceed 5%. For transport assessments, while steel exports are part of the output, we do not explicitly consider steel imports.

At the projected finished steel production and 6 times movement requirement, the total material transport (excluding coal for power plants captive to steel plants, slag to cement plants, and cement from cement plants captive to steel plants) would be 600mt in 2011-12 and 1200mt in 2019-20.

Based on the authors’ discussion with the executives of the newer steel plants, we expect almost the entire coking coal/coke to be imported and assume 50% of the thermal coal and 20% of the fluxes to be imported.

Table 1 summarizes the transport requirements (including the port linkages) for the steel industry.

Table 1: Transport Requirements

Commodity	2006-07	2011-12	2019-20
Finished steel	52.5	100	200
Domestic	39.4	75	150
<i>Exports</i>	<i>13.1</i>	<i>25</i>	<i>50</i>
Semi-finished and crude steel	38.1	65	130
Sponge iron	18.3	35	70
Raw material	196.5	400	800
Iron ore	111.9	225	450
Coking coal/coke	46.2	100	200
Domestic	-	-	-
<i>Imports</i>	<i>46.2</i>	<i>100</i>	<i>200</i>
Thermal coal	15.7	30	60
Domestic	7.8	15	30
<i>Imports</i>	<i>7.9</i>	<i>15</i>	<i>30</i>
Fluxes	22.9	45	90
Domestic	18.3	35	70
<i>Imports</i>	<i>4.6</i>	<i>10</i>	<i>20</i>
Total	305.6	600	1200
Port linkage (export+import)	71.8 (13.1+58.7)	150 (25+125)	300 (50+250)

[Source: Authors' Analysis]

Given the extent of movement that the growth in the steel industry would require, rail transport would become critical as a primary service provider.

5. Rail Based Movement

There are difficulties in making an accurate assessment of rail share for the steel industry, due to inherent problems in IR's statistical accounting methods. Aggregate freight data to 'steel plants' is getting documented in the 'Data Book' since 2006-07. Based on discussions with officers in the Railway Board, our sense is that only 'main' steel plants (RINL, SAIL, and Tata Steel) are considered. Non inclusion of the emerging 'major' steel plants (Essar Steel, Ispat Industries, and JSW Steel) is an issue, since there is significant movement to and from these plants. Exhibit 4 brings out our perceived lack of clarity in IR freight data wrt the steel industry.

We attempt to build the main commoditywise rail movement for the steel industry in table 2, based on our understanding of the industry structure (Exhibit 3) and some assumptions with regard to IR loading.

- Aggregate steel (finished steel, pig iron, and crude steel) figure of 27.0mt is 'Iron & Steel' figure as per the IR Year Book 2006-07.
- Iron ore figure of 77.5mt is the difference of 116.3mt (total iron ore) and 38.8mt (iron ore for exports) as per the IR Year Book 2006-07 and Data Book 2008-09 respectively.

- Coal figure of 50.9mt has been derived based on some assumptions. We assume that the movement of 25.3mt (55% of 46.2mt, which is the share of 'main' and 'major' producers) coking coal/coke to 'main' and 'major' producers is done entirely via rail. Of the remaining 20.9mt to 'other' steel plants and 15.7mt to sponge iron plants, 70% (25.6mt) is estimated as moving via rail from mines, but possibly to intermediate merchant locations and then by road to the respective plants. The remaining 30% would be direct by road to plants located close to mines.
- Fluxes figure of 12.7mt is as in the IR Year Book 2006-07.

Table 2: Commoditywise Rail Movement

2006-07

Commodity	Total (mt)	Rail (mt)	Rail Share (%)
Finished Steel	52.5	27.0	29.8
Pig Iron	5.0		
Crude Steel	33.1		
Sponge Iron	18.3	Negligible	Negligible
Raw Material			
Iron Ore	111.9	77.5	69.3
Coal	61.9	50.9	82.2
Fluxes	22.9	12.7	55.7
Total (Raw Material)	196.7	141.1	71.8
Total	305.6	168.1	55.0

[Source: IR MoR, 2008a; MoR, 2008b]

The above stated rail shares for 2006-07 seem to be in line with the estimates made in the NSP for 2004-05 where the rail share stated for raw material was 70% and for finished steel was 29%.

6. Importance of Steel Sector for Railways

Table 3 gives the overall profile of commoditywise loading, net ton kilometers (NTKM), and earnings that the IR had in 2006-07.

IR earned Rs 82,427 m from the steel industry, which was 20% of IR's total freight earnings. Of this, iron ore earned the maximum revenue at Rs 28,813 m, followed by pig iron & finished steel at Rs 26,007 m, and coal at Rs 20,396 m.

In terms of yield per mt, pig iron & finished steel was the highest at Rs 963 m and iron ore was the lowest at Rs 372 m, primarily reflecting the average lead of these commodities. In terms of yield per m NTKM, the highest was iron ore at Rs 1.16 m and the lowest was coal at Rs 0.86 m. This was a consequence of both the classification (for rates) and the lead (due to the telescopic structure).

Table 3: Profile of Steel Sector Commoditywise Rail Movement

2006-07

Commodity	Loading		NTKM	Lead	Earnings		Yield Per mt	Yield per m NTKM	Class
	mt	%			Rs m	%			
Finished Steel	27.0	3.7	26,635	986	26,007	6.2	963	0.98	180
Pig Iron									
Crude Steel									
Iron Ore	77.5	10.6	24,950	322	28,813	6.9	372	1.16	160
Coal*	50.9	7.0	23,782	467	20,396	4.9	401	0.86	140
Fluxes	12.7	1.7	6,983	550	7,211	1.7	568	1.03	160
Total (Steel Industry)	168.1	23.1	82,350	490	82,427	19.8	409	1.00	
Total Freight	727.7	100.0	4,80,993	661	417,175	100.0	573	0.87	

[Source: MoR, 2008a]

*To calculate NTKM and earnings, 25.3 mt coal moving to 'main' and 'major' producers is prorated on the 'coal to steel plants' figure, and the remaining 25.6mt is prorated on the total coal figure as per the Data Book.

7. Current Issues in Rail Transport

Depending on the rail share and size of the steel plant (Exhibit 5), there may be anywhere from four (for a 0.5mtpa crude steel producer) to nearly 40 rake movements per day (for a 5mtpa integrated steel producer) in and out of the plant. Similar assessments can be made for downstream producers, iron ore mines, coal mines, limestone and dolomite mines, and ports.

Given the significance of rail movement, we examine the issues related to rail transport in terms of infrastructure, technology and systems. These are based on discussions with functionaries in the industry and railways, questionnaire inputs from SAIL corporate office, and four steel plants (Rashtriya Ispat Nigam Ltd, Visakhapatnam (RINL), Tata Steel Ltd, Jamshedpur (TATA), Steel Authority of India Ltd, Salem (SAIL, Salem), Steel Authority of India Ltd, Rourkela (SAIL, Rourkela), a study visit to JSW Steel, Mormugao port and steel unloading points, and the authors' own perspectives based on prior visits to steel plants, iron ore mines, coal mines and ports.

Infrastructure

Streamlined Movement

- **Bypasses and Flyovers:** There are many junctions at which reversals take place, causing delays to the rake movement and congestion, and consequent asset utilization inefficiency. The same would be true with respect to flyovers in terms of cross movements. For example, in the case of JSW Steel, many rakes undergo reversals, either at Toranagallu, Bellary or Madgaon stations, causing additional delays to rakes of one to four hours.
- **Multiple Access:** Given the level of traffic at many steel plants, lack of multiple access in and out of steel plants leads to operational complexity, cross movements and consequent congestion.

Connectivity

- **Connectivity to Mines:** Due to lack of connectivity to mines, short haul movements are performed by road, resulting in IR's decreased market share in the high rated bulk commodity movement of iron ore.

Capacity

- While throughput has been increased by increasing the axle loading from 20.3 to 22.9 tons per axle and even up to 25 tons per axle in certain select routes, line capacity is a bottleneck in many sections. An example is the Hospet - Mormugao port single line section, which services coal imports for JSW Steel. Doubling of this section, and short of that, smaller debottlenecking works are on the anvil. However, project execution is not synchronized with the needs of the steel plant.

Terminals

- Infrastructure at terminals, especially at unloading centres (goods sheds) is quite poor [Raghuram G and S Bastian, 2008]. Apart from inadequate facilities and equipment, location of such goods sheds based on the 'station based goods shed' concept leads to congestion in the shed and evacuation problems.

Technology

Wagon Loadability

- There are certain commodities eg coking coal, pipes etc that cannot be loaded upto the carrying capacity (CC) of a wagon. In case of coking coal, the actual loadability is 58-60t (depending upon the type of coal) while the CC of BOXN wagon is 65t. As a result, the commodities, which cannot be loaded upto chargeable weight, are charged for their fixed chargeable weight based on the type of wagons resulting in idle freight. (SAIL, Rourkela)

Information System

- There are delays in receiving materials booked under rake load basis. FOIS (Freight Operations Information System), which generally gives the location of rake en-route, is also sometimes unable to provide the exact location of the rake and expected departure time in case the rake is stranded en-route. This adversely affects the planning to process materials at the steel plants (SAIL, Salem). Also, free access of FOIS for relevant data is not available as required (RINL).
- Steel plants do not get a committed forecast of empty wagons to be supplied within the next 24 hours. (SAIL)

Special Purpose Wagons/Wagon Design

- Wagons are not designed for size or handling of some special types of steel (tinplates, CRNO steel and pipes). BFNS wagons, which transport high quality value added steel

like coils, are not designed for protection from atmospheric influences. Customized wagons for specific finished steel products are not available.

- Availability of BFNS wagons is an issue. BRN wagons, which do not have saddles, are used as a substitute. As a result, steel producers need to take extra measures (and invest additional money) to ensure safe delivery of these products.
- BOXN wagons, while being the work horse of IR are not properly maintained. They often have problems in loadability of coal and iron ore fines, resulting in loss of material in transit due to spillage, leakage, flying off pilferage etc. (TATA).

Loading/Unloading Equipments

- Appropriate loading/unloading equipments are not always available at goods sheds. There are problems at loading/unloading points when IR is not able to supply the types of wagons suitable for a particular commodity. In case of loading of CR/HR coils (ideal for loading in BFNS wagons) in BOXN wagons, special equipments (eg crane attachments) are required to load/unload these coils in the desired position.

Systems

Unfit Wagons/Oversize Wagons

- There are frequent incidences of unfit wagons in rakes supplied by IR for loading (SAIL). For example, for each unfit wagon (at times, upto six unfit wagons in a rake), the complete wagon loader system at Mormugao port has to be stopped to skip the unfit wagon and restarted again. This results in increased cost of loading and time taken for rake loading. Apart from this, these unfit empty wagons cannot move up the ghat section as part of the loaded rake, due to which the wagons have to be removed at the foot of the ghat, at high operational costs.
- There are incidences of oversize wagons (BOXNHA) coming with BOXN rakes. These wagons cannot enter into the tippers as the tippers were designed to handle a maximum height of BOXN wagon. Such oversized wagons have to be isolated from the parent rake and unloaded manually. This increases detention to the rake and accrual of demurrage. (SAIL)
- Sometimes, wagons supplied by IR for loading come with left over material inside the wagon (Exhibit 6). This needs clearing up, causing operational complexity and delay for the customer.

Free Time/Demurrage/Idle Freight

- IR's demurrage and free time policy is not consistent towards newer and older steel plants. Newer plants are provided less time for demurrage (Exhibit 7).

Similarly, IR charges penal demurrage differently from zone to zone. (SAIL, Rourkela)

- While handing over the loaded rakes, steel plants inform railways to take over the rakes in the exchange yard and plant loco takes the rake upto the exchange yard. However, in case

there is a problem on railways part to take over the rake, the rake is detained inside the plant for which no extra free time is given. Only on physical arrival of rake at exchange yard, the take over time is recorded by railways. (SAIL)

Conversely, for empty rakes for steel loading, the demurrage clock starts from the moment the rake arrives at the exchange yard of steel plants, despite the demand time (which could be latter) indicated to railways. (SAIL)

- Due to material like coking coal and iron ore fines becoming sticky during the monsoon months, the unloading time of rakes increases. Earlier, railways used to provide monsoon allowances, which has been withdrawn. (SAIL)

Loading of long rails (130/260meter from Bhilai) to railway consignee requires more time, but no extra free time is given by railways. (SAIL)

- Steel plants place the indent for supply of empty rakes for dispatch of finished products and specify the type of wagons, type of rake and the demand time. However, there is a mismatch in the actual supply by railways. For example, due to shortage of BOST and BRN wagons, BOXN wagons may be supplied. Since the loadability (the chargeable weight) in the three types of wagons differ, the loading pattern and even the consignee may have to be changed. Apart from operational complexity, there could be demurrage and idle freight charges. (SAIL)
- Bunched arrival of rakes is a major reason for the detention of rakes in the plant. Though bunching allowance is provided by railways, at yards which do not have 24 hour working, the benefit ceases at midnight. This leads to operational complexity without due credit, especially if rakes are placed just before midnight. (SAIL)

Tariff Structure

- IR has increased freight tariff significantly, especially in the case of iron ore, by reclassification (Table 4).

Table 4: Reclassification of Freight Tariff

Year	Iron Ore for Steel Plants	Coal	Limestone & Dolomite	Steel
2004-05	120 130 (29/10-26/10) 140 (27/11-31-03)	140	140	180
2005-06	160 (15/05-31/03)	140	160	180
2006-07	160 (01/04-30/06) 170 (01/07-31/03)	140	160 (01/04-30/06) 170 (01/07-31/03)	180
2007-08	160 (01/04-06/01) 170 (07/01-31/03)	140	160	180
2008-09	180 (01/04-30.04) 170 (01/05-12/10) 180 (13/10-	140 (01/04-07/12) 150 (08/12-	160	180

[Source: MoR, Rates Circulars]

- IR has also increased the tariff through imposition of various surcharges on base freight like (i) busy season surcharge for nine months of the year, (ii) development surcharge, (iii) charges for using railway goodshed/siding, and (iv) multipoint booking surcharge. (SAIL, Rourkela)
- IR has also brought various incentives and discount schemes to customers. However, incentives schemes have many other conditions that some of the customers are not able to take any advantage. Further, there is delay in passing the benefits to customers (RINL).
- The number of freight rate circulars have been on the rise from 35 and 55 during 2003 and 2004 respectively to a range of 76 to 114 during the period 2005-2008. This makes it difficult for the customers and even for the railway officials to function, since before the absorption of the implication of one, another gets issued.
- The tariff structure has changed over the years, resulting in ores being charged at the same rate as steel. While this may not appear logical, especially as a proportion of the value of the product, it reflects a competitive perspective that IR has brought in into its tariff policy.

Weighing System

- There are occasions when weighbridge readings of railways are questionable, especially when it reflects a figure that would have been impossible to load. Punitive charges are also levied as per rules on these questionable weighments and refunds are then considered in a slow bureaucratic manner. IR does not accept the weighing records given by the raw material suppliers or the steel industry.

Rake Availability

- Preference in rake allotment is given to iron ore for exports rather than for steel plants. This becomes a risk for steel plants, who need to buffer with inventories. [Dave, Pandey and Sahni, 2008]

Multimodal Issues

- Due to lack of end to end solutions by IR, even in sections where it has competitive advantage over other modes eg mines to ports, commodities are handled by more than one mode. As an example, iron ore movement from mines in Hospet-Bellary region to Panaji/Mormugao port is executed by as many as four modes for a distance of less than 600 kms (Exhibit 8).
- Presently, dispatch of pipes is mainly by road transport as requirement of pipes are mostly at various project sites and away from major railway sidings. Railways do not provide a method to transport such pipes by bridging through road transport from the nearest railway station to the project site. (SAIL)

Claims/Refunds

- Customers find claim settlement mechanisms of IR very protracted. There are complaints of delays in refunding excess payments. This happens even in e-payment processes. (RINL). The Railway Rates Tribunal could be more effective. (SAIL, Rourkela)

Logistics Issues

- Rail provides only transportation while road transport carriers take various responsibilities including packing, securing and protection, and coverage of losses. (TATA)
- Railways are gradually reducing the number of 2-point rakes for steel dispatches, although it provides a lot of flexibility to the steel plants and the customers. Railways have indicated that in future, the facility of 2-point rakes for steel dispatches is likely to be withdrawn. (SAIL)
- Despatch of finished goods to minor destinations is a problem since rake load build up takes a while. (SAIL)

8. The Way Forward

Based on the estimated transport requirements (Table 1) for the steel sector in 2011-12 and 2019-20, we project the rail transport requirements by using the existing rail share (Table 2) and desirable rail shares of 50% for crude and finished steel, and 100% for raw materials. These projections are provided in Table 5.

The originating tonnage could go up from 168mt in 2006-07 to between 330-480mt in 2011-12 and 660-965mt in 2019-20. While steel transport requirements are expected to quadruple from 305mt in 2006-07 to 1200mt in 2019-20, the rail tonnage has the potential of going up six fold to nearly 1000mt, if appropriate steps in infrastructure, technology and systems are taken.

Table 5: Rail Transport Projections, 2011-12 and 2019-20

Commodity	Total (mt)	Rail Share (%)		Rail Movement (mt)	
		Existing	Desirable	At Existing Share	At Desirable Share
Finished Steel	100	29.8	50.0	49.2	82.5
Pig Iron	8				
Crude Steel	57				
Sponge Iron	35	Negligible		Negligible	
Raw Material					
Iron Ore	225	69.3	100.0	155.9	225.0
Coal	130	82.2	100.0	106.9	130.0
Fluxes	45	55.7	100.0	25.1	45.0
Total (Raw Material)	400	71.8	100.0	287.2	400.0
Total	600	55.0	80.4	330.0	482.5

[Source: Authors' Analysis]

2019-20

Commodity	Total (mt)	Rail Share (%)		Rail Movement (mt)	
		Existing	Desirable	At Existing Share	At Desirable Share
Finished Steel	200	29.8	50.0	98.4	165.0
Pig Iron	16				
Crude Steel	114				
Sponge Iron	70	Negligible		Negligible	
Raw Material					
Iron Ore	450	69.3	100.0	311.8	450.0
Coal	260	82.2	100.0	213.8	260.0
Fluxes	90	55.7	100.0	50.2	90.0
Total (Raw Material)	800	71.8	100.0	574.4	800.0
Total	1200	55.0	80.4	660.0	965.0

[Source: Authors' Analysis]

Infrastructure

- The origin-destination (OD) flows at a disaggregate level would give a better assessment for validating the rail share and infrastructure requirements. Key parameters to be conscious of would be the market spread, expected parcel sizes, OD lead, nature of source (mine, port, or plant), nature of destination (plant, stockyard, or port). The authors have developed a model for such an assessment for the IR freight as shown in Exhibit 9.

IR should assess the OD flows of finished and crude steel, pig iron and sponge iron, and raw materials for steel making and plan the infrastructure in terms of route capacity, terminals and rake requirements. Exhibit 10 gives a map of the proposed capacity additions upto 2011-12. Similarly, Exhibits 11 and 12 give maps of the coal and iron ore reserves respectively. All the maps indicate distinct cluster based development potential.

- Port connectivity requirements can be assessed based on Table 1. For plant to port flows, in terms of finished steel, 25% is expected to be exported, of which 50% would move by rail. Similarly, for port to plant flows, in terms of raw materials, 100% of coking coal/coke, 50% of thermal coal, and 20% of fluxes are expected to be imported, of which 100% would move by rail. For 2019-20, these would translate to 25mt of finished steel, 200mt of coking coal/coke, 30mt of thermal coal, and 20mt of fluxes. Hence, steel plant port connectivity infrastructure should be developed, recognizing this level of movement.
- Rail based unloading stockyards for finished steel would need to be developed for handling upto 75mt in 2019-20. Of this, the demand would be concentrated in areas near metros. It would be fair to expect that 50mtpa would be unloaded in the top 10 metro areas with a throughput of 5mtpa each. For these metros, captive unloading stockyards (steel logistics parks with warehousing infrastructure) with sophisticated infrastructure and evacuation options should be developed under a public private partnership model.

Technology

- IR should continue the thrust towards increased axle loading, special purpose wagon design, and ensuring loadability to minimize idle freight. The standards for the dedicated freight corridor should recognize these.
- Containerized movement of finished steel has begun. This has significant potential and should be facilitated, both due to its multi modal possibilities and the scope of leveraging the private container operators.
- For raw material handling at tipplers, rotary couplers should be incorporated in the wagon design for quicker unloading.
- There should be focus on special purpose wagon design to facilitate commodity specific handling and logistics requirements. For example, being able to load coils in 'eye horizontal' position would reduce losses and make it easier for handling.
- While special purpose wagon design has its advantages, a perspective on using the same wagon for inward and outward could reduce transportation costs significantly. Plants and ports have substantial inward and outward movement. The maximum scope for this concept is 165mt at plants, implying 330 rake movements per day and 25mt at ports, implying 50 rake movements per day.
- Continuous improvement in wagon design is a must. To ensure this, the IR policy of allowing any entity including wagon manufacturers to come up with wagon designs should be sustained. The RDSO should be the body to accept the wagon design, after due simulations and trials.
- There should be complete visibility on wagon and rake movements. Technologies such as GPS and RFID should be used for this. Information systems such as FOIS should be made more integrated, robust, and user friendly.

Systems

- Supply chain coordination with customers and suppliers should be of a significantly higher order. Using FOIS, trains movements in and out of mines, ports, plants and unloading centres should be regulated to ensure streamlined logistics.
- While 3000 tons plus parcel sized rakes are in general okay, there could be OD segments for which customers may not be able to bear the inventory related costs. Depending on the opportunity cost of capacity on such segments, smaller, but modular rake sizes should be considered.

In the same context, multi-point rakes, especially for smaller stockyards, should be leveraged.

- There is significant strategic opportunity in leveraging the empty spaces in steel carrying wagons. Steel is a high density cargo, in the range of 7500-8000kg/m³. A typical steel loading wagon has a volume of about 70m³. When steel coils of 65-67 tons are loaded in

a wagon, it occupies only about 12% of the wagon's volume (Exhibit 13a). If steel is loaded together with a compatible low density cargo (for example, packaged bulk agricultural products), there can be significant revenue additionality for IR (Exhibit 13b). IR should explore such opportunities, if required by influencing the development of industries with compatible cargo.

Exhibit 1 Major Country Crude Steel Production

Calendar Year \ Country	2001	2002	2003	2004	2005	2006	2007	2008
China	150,906	182,249	222,413	280,486	355,790	422,660	489,241	500,488
Japan	102,866	107,745	110,511	112,718	112,471	116,226	120,196	118,738
United States	90,104	91,587	93,677	99,681	94,897	98,557	98,181	91,490
Russia	58,970	59,777	61,450	65,583	66,146	70,830	72,220	68,510
India	27,291	28,814	31,779	32,626	45,780	49,450	53,080	55,050
All Countries	850,266	903,929	969,743	1,068,691	1,146,203	1,249,997	1,344,265	1,329,719

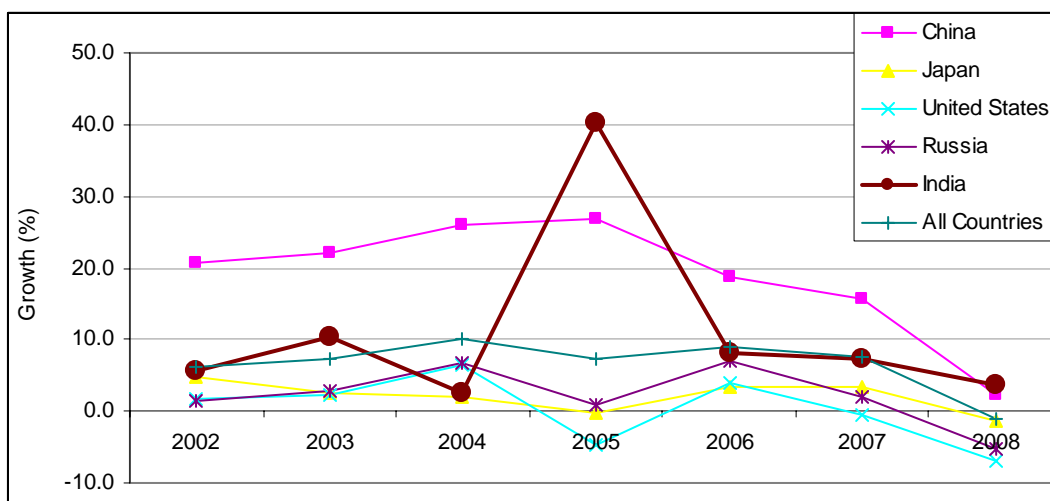

[Source: World Steel Association, <http://www.worldsteel.org>]

Exhibit 2 Additional Steel Capacity by 2020 as per MoUs

State	Total MoUs	Capacity (mt)	Investment (Rs bn)
Orrissa	45	78.2	1923.8
Jharkhand	57	91.7	1785.0
Chattisgarh	57	33.8	892.3
West Bengal	12	21.0	333.3
Maharashtra	2	3.2	46.7
Gujarat	9	8.7	95.8
Others	11	6.3	63.6
Total	193	242.9	5140.4

[Source: Cygnus, 2008]

Exhibit 3

Steel Industry Structure and Transport Flows

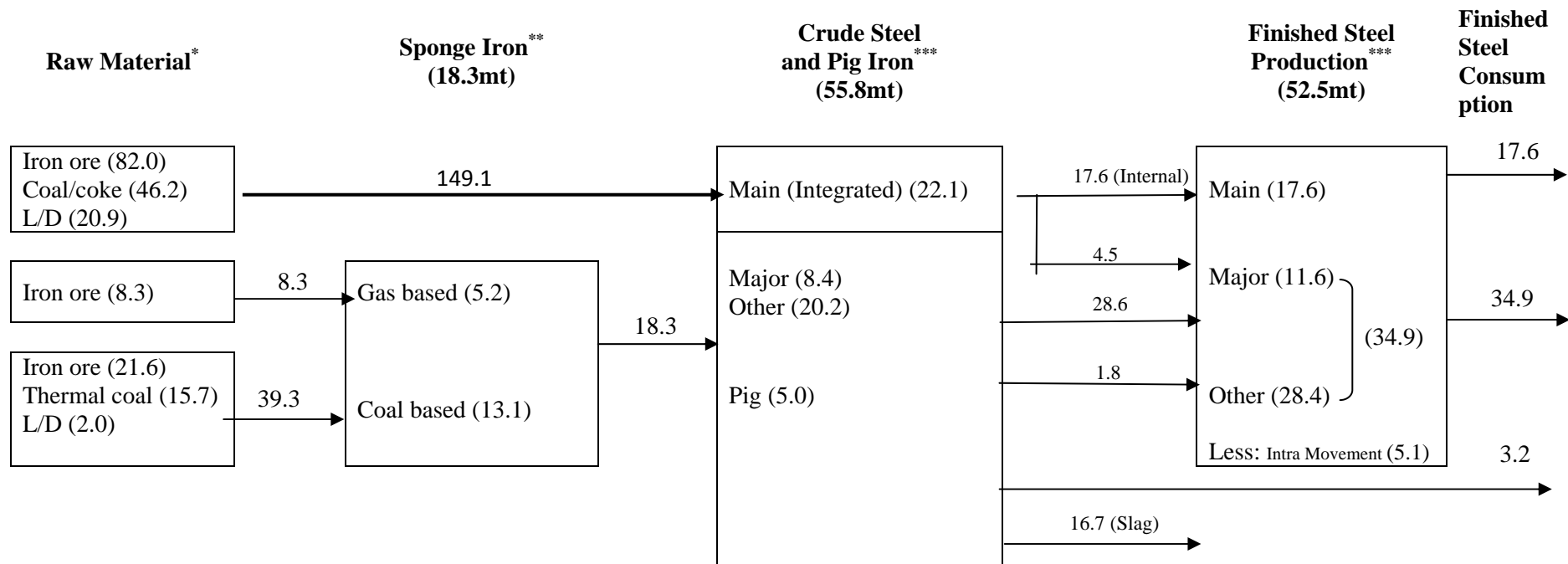

Main: SAIL, TATA, and RINL; **Major:** Essar, Ispat, and JSW Steel; **Other:** A large number of mini steel plants (based on electric furnaces and energy optimizing furnaces)

*Raw material is estimated to be 3 times the crude and pig iron production.

** Iron ore is the major raw material for the gas based plants, which is about 1.6 times the production. Coal based plants require 55% iron ore, 40% thermal coal, and 5% fluxes as raw material. (There are three gas based sponge iron making plants (producing 5.2mt) while 147 coal based plants (producing 13.1mt) in the country)

***direct from Ministry of Steel Annual Report 2006-07

Total material transport: $149.1+8.3+39.3+18.3+4.5+28.6+1.8+17.6+34.9+3.2=305.6$ (excludes slag, cement, and coal for power)

[Source: Authors' Analysis]

Exhibit 4

Lack of Clarity in IR Freight Data wrt Steel Industry

Publication	Head	Remark
Year Book	Raw materials to steel plants	Which raw materials are included? Which steel plants are included?
Year Book	Limestone & dolomite	Split for steel plants?
Year Book	Pig iron and finished steel from steel plants	Which steel plants are included? Clarity on how are these two figures different?
Year Book	Iron & steel	
Data Book	Coal for steel plants	Is thermal coal to power plants captive to steel plants included? Which steel plants are included?
Data Book	Coal to thermal power houses	Is thermal coal to power plants captive to steel plants included?
Data Book	Iron ore for steel plants	Which steel plants are included?
Data Book	Iron ore for other users	Who are these other users?
Data Book	Pig iron and finished steel from other points	Which are these other points?

[Source: MoR, 2008a; MoR, 2008b; Authors' Analysis]

Exhibit 5 Steel Plants (Above 0.5mtpa Capacity)

2006-07

	Plant	Location	Capacity (mtpa)	Crude Steel Production (mtpa)
1.	Tata Steel, Jamshedpur	Jharkhand	5.00	5.17
2.	SAIL, Bhilai	Chattisgarh	3.92	4.80
3.	SAIL, Bokaro	Jharkhand	4.36	4.07
4.	Rashtriya Ispat Nigam Ltd, Vishakhapatnam	Andhra Pradesh	2.91	3.50
5.	Ispat Industries Ltd, Raigarh	Maharashtra	3.00	2.76
6.	JSW Steel, Vijayanagar	Karnataka	3.80	2.64
7.	Essar, Hazira	Gujarat	4.60	2.40
8.	SAIL, Rourkela	Orissa	1.90	1.99
9.	SAIL, Durgapur	West Bengal	1.80	1.87
10.	Jindal Steel & Power Ltd, Raigarh	Maharashtra	1.37	0.80
11.	Jindal Stainless Ltd, Hisar	Haryana	0.60	0.59
12.	Lloyds Steel Ltd, Wardha	Maharashtra		0.54
13.	SAIL, IISCO	West Bengal	0.50	0.47
	Total of Above			31.60
	Others			19.22
	Total			50.82

[Source: MoS, 2008]

Exhibit 6 Left Over Material Inside Wagons



[Source: SWPL]

Exhibit 7

Free Time and Demurrage

Free Time: It's the time from Rake arrival at site until the rake is handed over back to the Railways after completion of loading/ unloading activities.

Free time for loading/unloading of wagons and allowances applicable in the case of seven old steel plants

Seven old steel plants namely Bhilai Steel Plant, Bokaro Steel Plant, Durgapur Steel Plant, Indian Iron & Steel Co., Rourkela Steel Plant, Tata Iron & Steel Co. and Visakhapatnam Steel Plant will be permitted free time as prescribed below:

Type of wagon	Name of the Steel Plant	Number of wagons	Permissible free time (in hours)	
			Loading	Unloading
Open wagons	Visakhapatnam Steel Plant	Upto 35	16	8
		36 & above	18	10
	Indian Iron & Steel Co.	Upto 35	24	16
		36 & above	26	18
	All others	Upto 35	22	12
		36 & above	24	14
Flat wagons	All	Upto 35	24	12
		36 & above	26	14
Hopper wagons	All	Upto 45	N.A.	8
		46 & above	N.A.	10
Covered wagons	All	Irrespective of the number	24	24
Tank wagons	All	Irrespective of the number	24	24

Free time for loading/unloading of wagons and allowances applicable in case of all other steel plants

Permissible free time for loading/unloading of wagons and allowances applicable in the case of steel plants other than the above mentioned seven old steel plants will be as under:

Type of wagon	Number of wagons	Permissible free time (in hours)	
		Loading	Unloading
Open wagons	Irrespective of number of wagons	12	8
Flat wagons		12	8
Hopper wagons		N.A.	4
Covered wagons		10	10
Tank wagons		9	9

N.A. stands for 'not applicable'.

Demurrage: Demurrage is the charge levied for the detention of any rolling stock after the expiry of free time, if any, allowed for such detention.

Rates of demurrage Charge

In case of steel plants, demurrage charge @Rs.50/- per 8-wheeled wagon per hour, or part of an hour, for detention of wagon in excess of the permissible free time for loading or unloading, shall be levied.

[Source: MoR, Rates Circular No 74 of 2005]

Exhibit 8 Multimodal Movement of Iron Ore

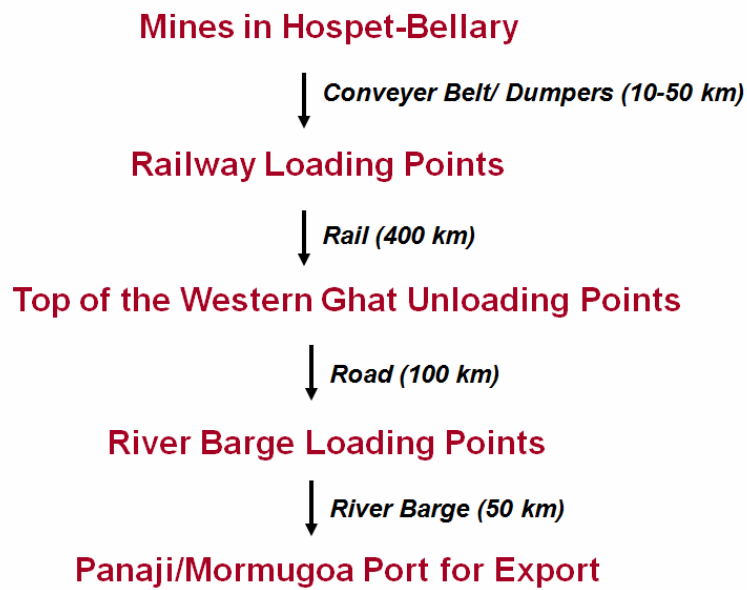

[Source: Authors' Analysis]

Exhibit 9
Origin Destination Flow for IR (2006-07)

Total Traffic: 727.8mt

Origin \ Destination	Industry (411.3)	Ports (78.3)	Distribution Centres (238.2)
Industry/ Collection Centres (224.5)		Containers (16.4) POL (5.6) Total (22.0)	Cement (73.1) Foodgrains (39.0) Fertilisers (27.2) Iron and steel (25.5) POL (17.2) Other commodities (12.2) Salt (4.6) Sugar (3.7) Total (202.5)
Mines (424.1)	Coal (261.5) Iron ore/other ores (80.3) Limestone/dolomite (12.7) Stones, excl marble (10.0) Gypsum (3.2) Total (367.8)	Iron ore/other ores (40.9) Coal (15.4) Total (56.3)	
Ports (79.1)	Coal (36.4) Other commodities (6.6) Iron ore/other ores (05) Total (43.5)		Containers (15.3) POL (8.9) Fertilisers (7.1) Foodgrains (2.8) Iron and steel (1.6) Total (35.7)

[Source: Raghuram G and R Gangwar, 2008]

Exhibit 10 Proposed State Wise Capacity Additions upto 2012

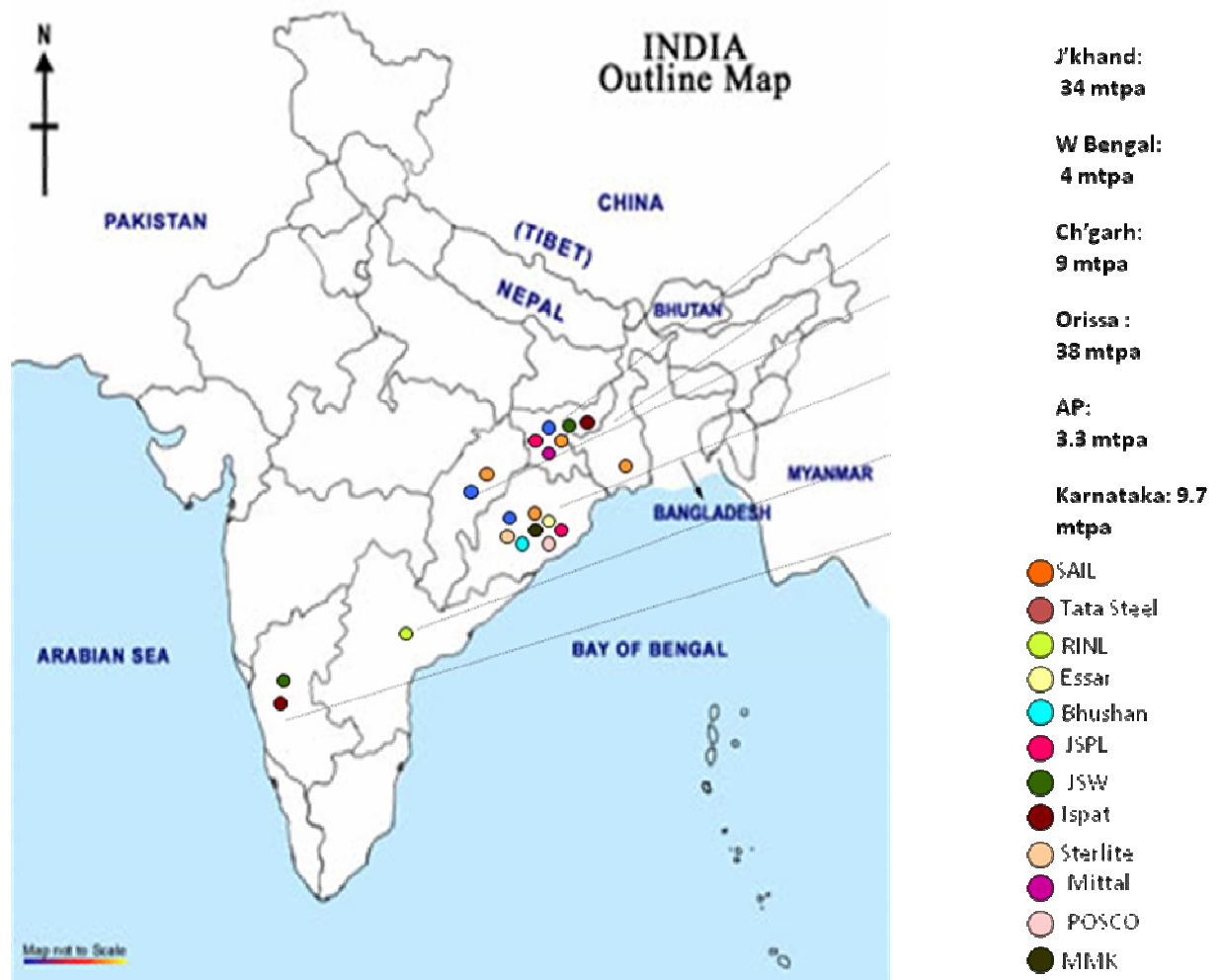

[Source: Pandey A K, 2006]

Exhibit 11 Indian Coal Reserves (billion tons)

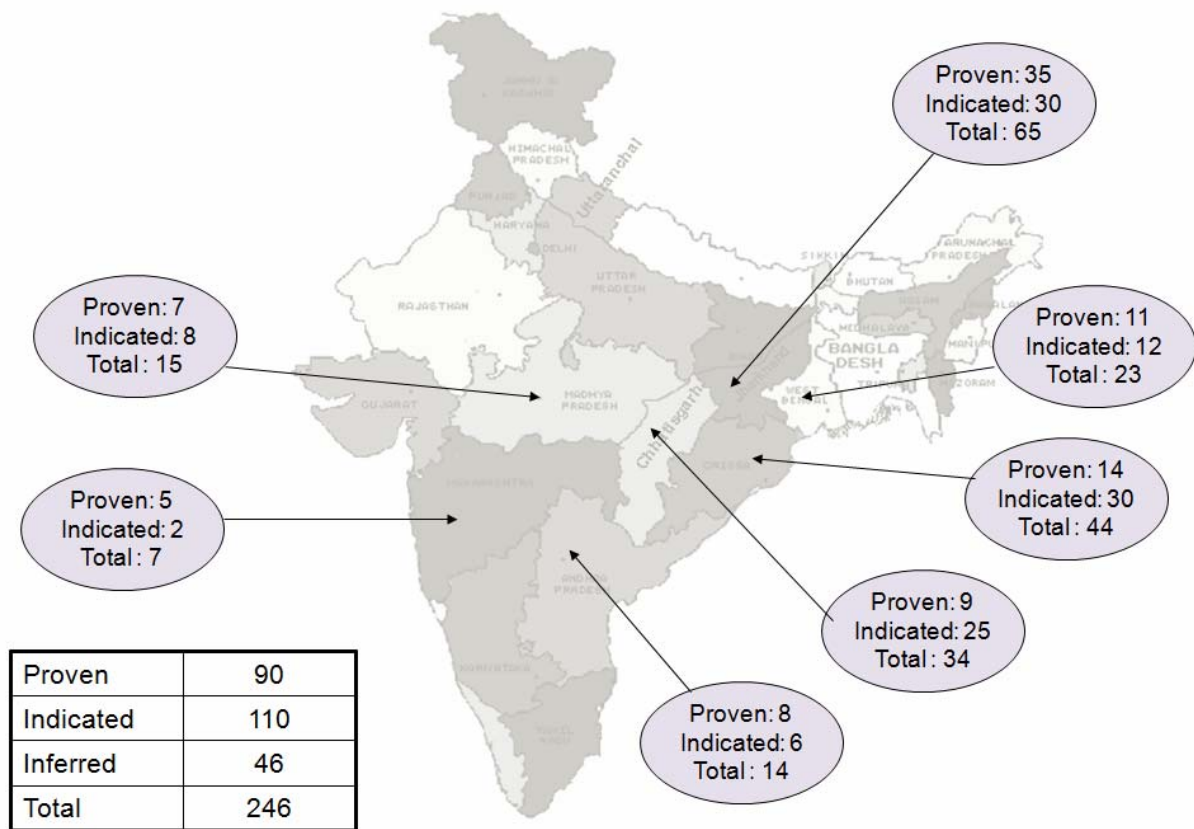

[Source: Pandey A K, 2006]

Exhibit 12 Iron Ore Reserves

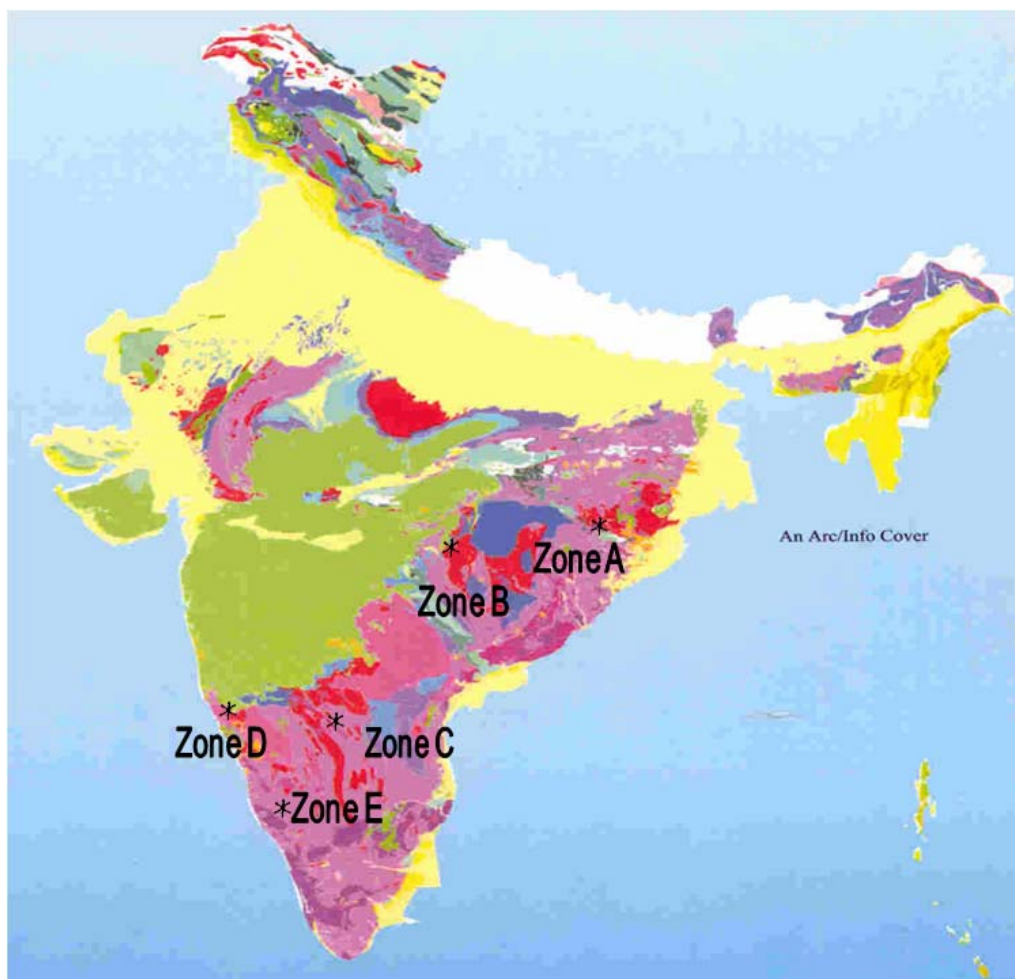

Zone	States	Major Mines / Deposits
A	Orissa, Jharkhand	Chiria, Noamundi, Joda, Kiriburu, Meghataburu, Thakurani, Bolani, Gua, Malangtoli, Gandhamardan, Daitari
B	Chattisgarh, MP, Maharashtra	Bailadila, Dalli Rajhara, Rowghat, Mahamaya, Aridongri, Surajgarh
C	Karnataka	Donimalai, Ramandurg, Kumaraswamy, NEB Range, Ettinahatti, Tumti, Belagal
D	Goa	N Goa, S Goa, Redi
E	Karnataka	Kudremukh, Bababudan, Kudachadri

[Source: Baijal A D, 2006]

Exhibit 13a Weight Volume Mix

	BFNS Wagon	BOXN Wagon
Wagon dimensions (mm)		
Length	13716	9784
Height (loadable)	1650	2233
Width	3045	3200
Wagon volume (m3)	69	70
Steel density (kg/m3)	7861	
Steel volume at 65 tons (m3)	8.3	
Steel volume at 67 tons (m3)	8.5	
Wagon utilization (%)	12.0	12.1

[Source: Authors' Analysis]

Exhibit 13b Weight Volume Mix

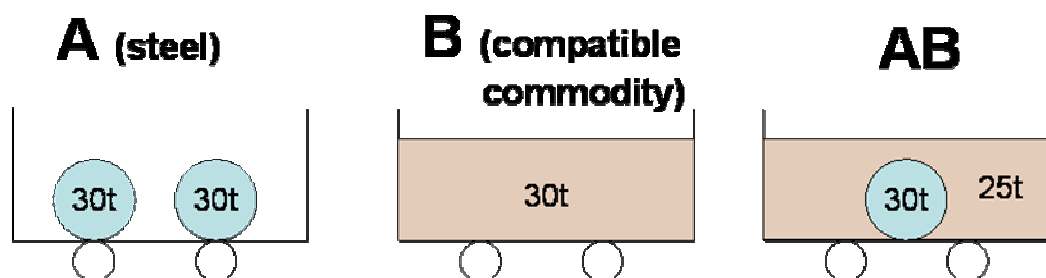

A: We consider nine wagons, each carrying 60 tons of steel, limited by weight. (A total of 540 tons)

B: We consider 15 wagons, each carrying 30 tons of a compatible cargo (CC), limited by volume. (A total of 450 tons)

AB: Instead of the 24 wagons, the 540 tons of steel and 450 tons of CC can be carried in 18 wagons, each carrying 30 tons of steel and 25 tons of CC.

The AB type of loading provides a saving of 25% on total wagon requirements.

About 27mt of steel were loaded in 2006-07. At a 60 ton per wagon loading, this amounted to 450,000 wagons of steel loading. We assume the availability of 750,000 wagon equivalent of CC (22.5mt) going in the same OD segments as the steel. Out of the total 1,200,000 wagons, with a total loading requirement of 49.5mt of steel and CC, at a 55 ton per wagon loading, 900,000 wagons would be loaded. A total of 300,000 wagons would be released for alternate use.

This has a potential revenue additionality of Rs 1500 crores, assuming a release of 300,000 wagons for a lead of 1000 kms (approximate lead for steel), with a loading of 50 tons, and earning of Rs 1 per ton km.

[Source: Authors' Analysis]

Visits and Meetings

June 9, 10 & 11, 2008, Delhi

Mr Sanjay Kumar Jain, Sr DOM
Mr Rakesh Saxena, DRM, Delhi
Mr B K Shukla, Sr DOM (Planning)
Field Visit, Ghaziabad
Railway Board, Traffic Directorate

July 11, 2008, Goods Shed, Ghaziabad

Field Visit

August 26, 2008, Bescos Ltd (Rail Wagon Manufacturer), Kolkata

Mr O P Tantia, Chairman

October 08, 2008, Bhushan Steel, Delhi

Mr B B Singal, Chairman

August 27, 2008, Railway Board, Delhi

Mr K C Jena, Chairman

December 30, 31, 2009 and January 01, 2009, JSW Steel, Vijaynagar

Mr Srinivas Batni, Associate Vice President – Marketing
Mr U G Pawar, Head, Logistics
Mr K Raman, Dy General Manager - Logistics
Mr Y Siva Sagar Rao, Joint Managing Director & Chief Executive Officer

January 02, 2009, South Western Railway, Hubli

Mr S K Behera, Chief Commercial Manager
Dr Anup Dayanand, Sr DOM (Coord)
Mr D Govind Kumar, Chief Rolling Stock Engineer
Mr Braj Mohan, Chief Operations Manager
Mr U Krishna Murthy, Chief Freight Transportation Manager
Mr A S Rao, CCM (Marketing)
Mr S Subramaniam, Sr DOM (Goods)

January 03, 2009, Mormugao Port, Mormugao

Mr Praveen Agarwal, Chairman, MPT
Mr Rajendra R Kondebettu, AGM – O & M, SWPL
Mr K C Kuncheria, Chief Mechanical Engineer, MPT
Mr P Ch Rama Chandra Rao, Sr Vice President, SWPL
Mr Trevor Silveira, Asst Executive Engineer, MPT

References

1. Bajjal, A D, 2006. 'Raw Material Outlook for India: A Review,' VP (Raw Materials), TATA Steel, conference presentation in 'Situation and Outlook for Steel,' OECD, International Iron and Steel Institute, and Government of India, May 16-17, 2006. New Delhi.
2. Dave, H, R Pandey and S Sahni, 2008. 'How can Indian Railways Service the Steel Sector Better?,' Summer Training Report, CEPT University, Ahmedabad.
3. Cygnus, 2008. 'Indian Steel Industry - Quarterly Performance Analysis of Companies: October-December 2007,' Cygnus Business Consulting and Research, Hyderabad.
4. Pandey A K, 2006. 'Raw Material and Transportation: Issues and Outlook,' GM, SAIL, conference presentation in 'Situation and Outlook for Steel,' OECD, International Iron and Steel Institute, and Government of India, May 16-17, 2006. New Delhi.
5. Raghuram, G and S Bastian, 2008. 'Ghaziabad Goods Shed: Strategies for Improved Servicing of the Customer,' IIMA/PSG0105, Indian Institute of Management, Ahmedabad.
6. Raghuram, G and R Gangwar, 2008. 'Freight Business Marketing Model for Indian Railways,' India Infrastructure Report -2008, 3iNetwork, Oxford University Press, New Delhi.
7. Raghuram, G and R Gangwar, 2009. 'JSW Steel Ltd: Logistics at Vijayanagar Works,' Indian Institute of Management, Ahmedabad.
8. MoR, 2008a. 'Indian Railways Year Book 2006-07,' Ministry of Railways, Government of India, New Delhi.
9. MoR, 2008b. 'Data Book 2008-09,' Ministry of Railways, Government of India, New Delhi.
10. MoS, 2005. 'National Steel Policy 2005,' Ministry of Steel, Government of India, New Delhi.
11. MoS, 2008. 'Annual Report 2007-08,' Ministry of Steel, Government of India, New Delhi.